



Independent Protection Co., Inc.

1607 South Main St.

Goshen, IN. 46526

574.533.4116 or 1.800.860.8388

Fax: 574.534.3719

info@ipclp.com www.ipclp.com

UL Listing No. E10913

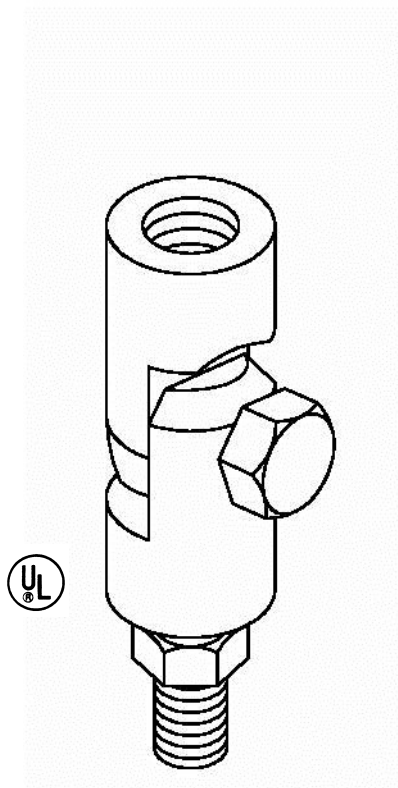

MADJ12FT38MB

**Adjustable Adaptors Female Top
to Male Bottom**

Machined brass
1/2" female top
3/8" male bottom
Wt. .36 lbs. each.