



Independent Protection Co., Inc.

1607 South Main St.
Goshen, IN. 46526

574.533.4116 or 1.800.860.8388

Fax: 574.534.3719

info@ipclp.com www.ipclp.com

UL Listing No. E10913

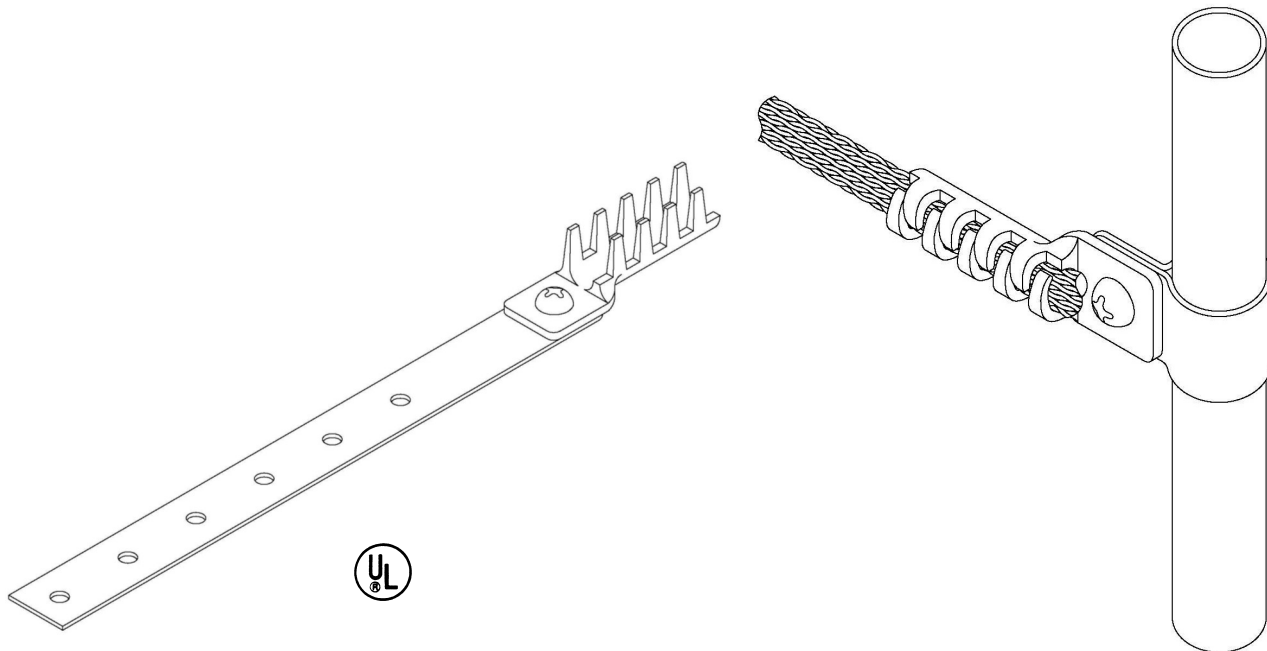

215 Band Style Bonding Strap

Cast bronze crimp style fitting IP-5 with IP-49 copper strap for use with bonding metal bodies up to 2" diameter pipe. Longer lengths available upon request. Wt. .28 lbs. each.

22	28S	32S	40	21	GS	A22	A28	A30
----	-----	-----	----	----	----	-----	-----	-----